



HERITAGE CLASSIC™

Handcrafted Wood Carriage Style Garage Doors

HÖRMANN

Heritage Classic, Handcrafted by Northwest Door



Left Model EX16A, Right Model EX20A

Heritage Classic's are hand-crafted overhead sectional wooden garage doors that replicate old-fashioned swing-type doors. Northwest Door takes great pride in manufacturing these fine garage doors and has over seventy years experience. Similar looking doors are available from other manufacturers, however there is no substitute for the Heritage Classic's superior quality and craftsmanship.

Unique features:

- Heavy-duty wood frame
- Unlimited sizes
- 3-section design
- Custom arches
- Exterior grade plywood door skins are pressure laminated to both sides of the door frame
- Wood overlay is relief cut and has a 7° taper at section joints
- Water break at base of door beneath overlay
- Commercial grade industrial torsion spring hardware
- Each door section supplied with a steel strut for maximum reinforcement
- Frequently spaced intermediate hinges
- Double end hinges
- Threaded inserts for securing hardware
- Aluminum retainer with vinyl boot-type bottom weather seal
- ***Skilled artisans build every Heritage Classic door with pride using fine quality materials and personally sign each door they create. Our craftsmen have an average of more than 10 years of experience.***



Construction

E Series

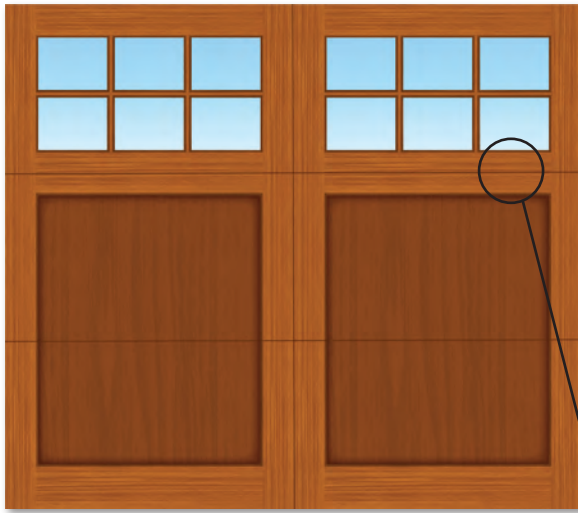

Overall Thickness, Nominal 2-1/4"

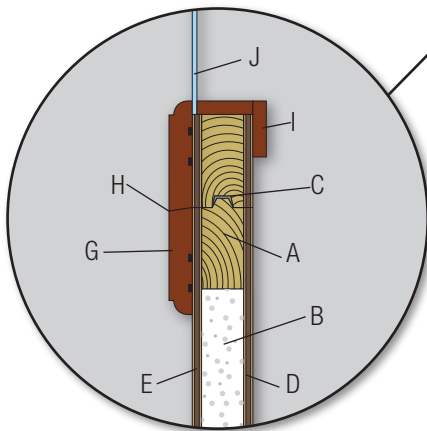

C Series

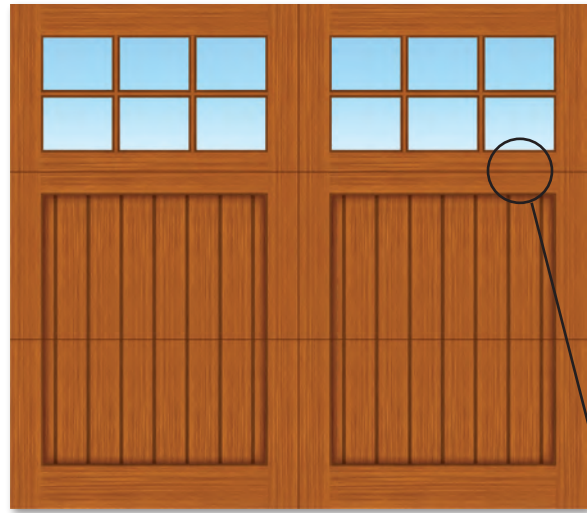

Overall Thickness, Nominal 2-7/8"

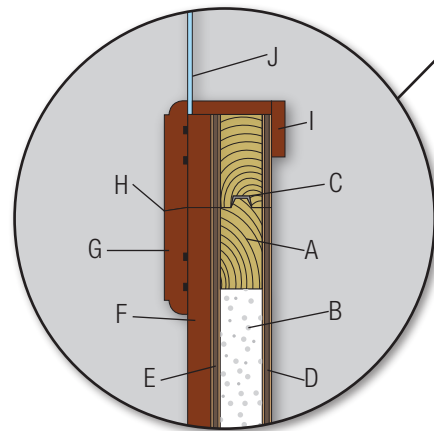

A - Heavy-Duty nominal 1-1/8" thick Hem/Fir frame

B - Nominal 1-1/8" Polystyrene (EPS) insulation

C - Tongue & Groove section joints

D - (Back) Nominal 1/4" exterior grade plywood pressure laminated to frame with waterproof contact adhesive (Luan standard)

* E - (Front) Nominal 1/4" exterior grade plywood pressure laminated to frame with waterproof contact adhesive (Luan standard)

** F - (C-Series Only) 1x6 T&G wood applied vertically to the door face using Marine Grade urethane adhesive and toe nailed with stainless steel fasteners. (Western Red Cedar or Meranti standard)

*** G - Nominal 5/8" wood overlay, relief cut to resist twisting or warping then adhered to the door face with waterproof adhesive and stainless steel pin nails. Pin nail holes are filled with putty and sanded smooth on paint grade doors, stain grade doors are not filled. (Western Red Cedar or Meranti standard)

H - 7° taper on overlay at section joints

I - Nominal 3/8" removable wood window stop (material to match overlay material)

**** J - True-Divided Lites (1/8" clear annealed glass standard)

* Note: Optional 3/8" exterior grade rough sawn Okume plywood, 3/8" MDO Fir plywood (paint only) (with or without grooves) plus other optional plywood

** Note: Optional 1x4, 1x6, 1x8 T&G VG Fir, Tight Knot Cedar, 1/2" Extira® exterior wood composite plus other optional woods

*** Note: Optional VG Fir, Tight Knot Cedar, 1/2" Extira® exterior wood composite plus other optional woods

**** Note: Optional obscure, tinted or insulated glass

Door Operation Types

Heritage Classic doors can be constructed for different types of operation:

- Sectional, Overhead (Standard)
Operational Hardware Included
- One Piece, Overhead or Sliding (Optional)
Operational Hardware not included
- Bi-Parting, Swinging Type or Sliding (Optional)
Operational Hardware not included

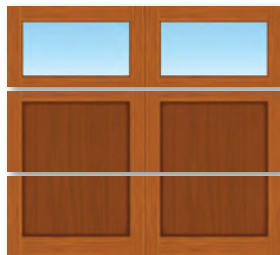

Sectional (Standard)



One Piece

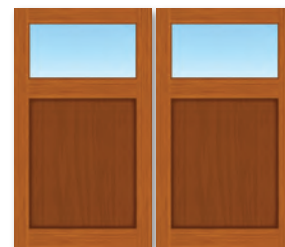

Bi-Parting

Overlay Profiles

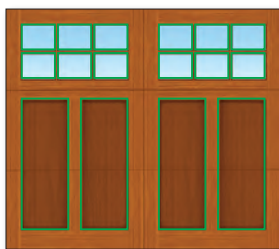

Standard overlay sizes: Top Rail and End Stiles, 1x6 (5-1/2" finished), Bottom and Intermediate Rail, 1x8 (7-1/2" Finished). 5 overlay profiles are available:

(A) 7/16" Radius (Standard)

(B) Square Edge

(C) Eased Edge

(D) Bevel Edge, 30-35°

(E) *Chamfer Edge, 3/8"x3/8" 45°.

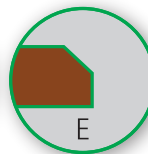
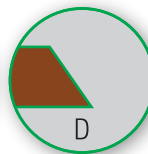
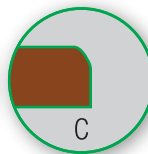
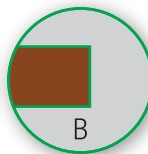
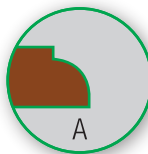

*Note: Full Chamfer and Partial Chamfer available, Partial Chamfer is held back 2" from corners.

Door Arches



15'-0" Radius (Standard)



Double Car Door, Two 15'-0" Radius Arches (Standard)



Double Car Door, 58'-0" Radius Arch

C-Series Face Material Sizes, Profiles and Configurations - 1x6 V-Groove T&G Shown

T&G Face Material, is available in 1x4, 1x6 (Standard) or 1x8, in 4 profiles and applied in 7 various configurations.

T&G profiles:

- (1) V-Groove (Standard)
- (2) Butt-Joint
- (3) Beadboard
- (4) Double Beadboard

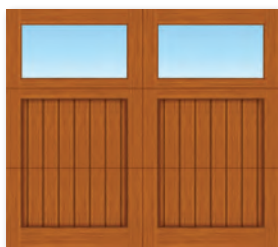

Vertical (Standard)



Horizontal



Diagonal A Pattern, 45°



Diagonal V Pattern, 45°

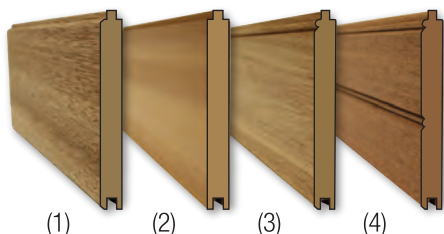

(1)

(2)

(3)

(4)



Herringbone A Pattern, 45°



Herringbone V Pattern, 45°



Diamond Pattern, 45°

Wood Types

WOOD OVERLAYS

The standard wood used on the overlay on Heritage Classic E and C Series and the face material on C Series is your choice of Western Red Cedar or Meranti. In addition a wide selection of other fine woods are available such as VG Fir, Redwood, Tight Knot Cedar, Alder and other specialty woods upon request. 1/2" Extira® exterior grade wood composite is also available however it is paint grade only.

PLYWOODS

All plywood used on Heritage Classic E and C Series doors is Exterior Grade. Luan plywood is standard for smooth surfaces and Okume plywood for rough sawn surfaces. 3/8" MDO Fir plywood is also available however it is paint grade only.

WOOD DOOR FRAMES

Wood door frames are manufactured using kiln dried Western Hemlock and/or Douglas Fir. We refer to these woods as Hem/Fir as one or both woods may be used. These woods are grown and harvested from forests that follow Sustainable Forest Practices.



Wood Finishing

When properly finished and maintained a Heritage Classic garage door will remain beautiful and give you many years of service. Finishing instructions and complete warranty information can be found on our website at www.NorthwestDoor.com. For best results we recommend using a quality professional wood finisher to finish your garage door.

Note: At no time should your wood garage door be allowed to get wet before a protective finish is applied. Primer without a top coat is not considered a protective finish. All surfaces of the garage door; interior, exterior, sides, edges and meeting rails must have a protective finish prior to installation.



Hardware Specifications

- Commercial Grade Continuous Angle Mounted Standard Lift Track
 - 2" Track to 590 lbs - 12", 15", 20" or 30" Radius
 - 3" Track, over 590 lbs - 15" Radius
- Oil Tempered Torsion Springs, 10,000 cycle
- Solid Keyed Shaft, 11 Gauge Keyed Tube or 14 Gauge Tube
 - According to Door Weight and/or Size
- One Galvanized Horizontal Strut Per Door Section
 - 2" Struts to 180" Wide Door
 - 3" Struts over 180" Wide
- 14 Gauge Double End Hinges, Intermediate Hinges and Intermediate Half Hinges
- Galvanized Interior Slide Lock
- Galvanized Interior and Exterior Lift Handles

Hardware Options

- High Cycle Springs
- Reverse Angle Mounting for Steel or Masonry Jamb
- Low Clearance Track and Hardware
- High Lift Track and Hardware
- Vertical Lift Track and Hardware
- Follow Roof Pitch Track and Hardware
- **Powder Coated Hardware**, shown below with optional follow the roof slope track and hardware.
 - *Note: Finishes available in Black, Red, Grey, White, Brown and Custom Colors



Steel Struts
Double End Hinges
Intermediate Half Hinges
Standard Intermediate Hinges

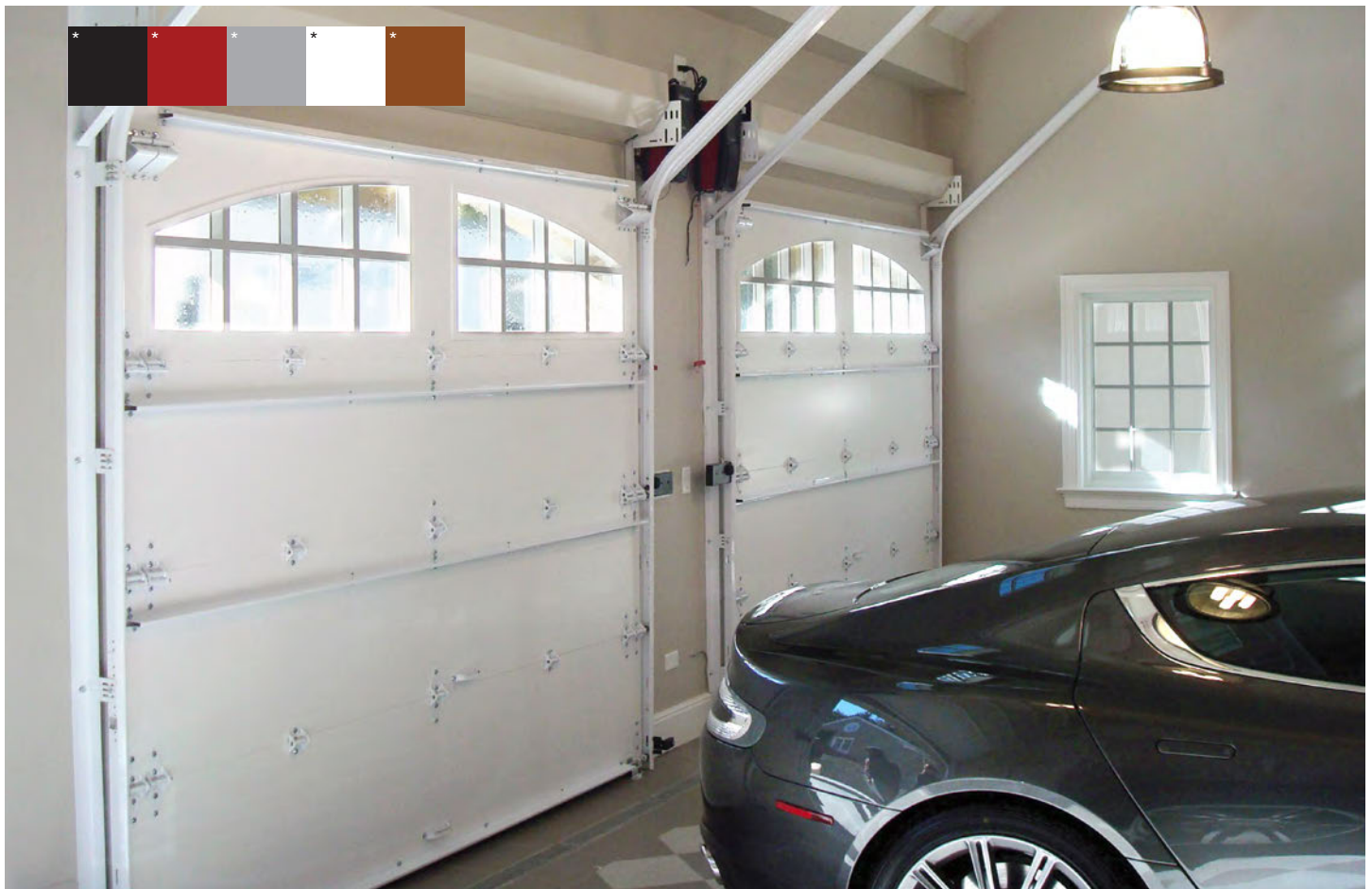

*Note: The color images shown will vary from actual colors due to the printing process.



Model C006S
1X6 V-Groove T&G Face Applied Vertically (Standard)

C Series "0" Designs



C000A C001A C002A C003A C004A C006A C008A



C000S C001S C002S C003S C004S C006S C008S C009S

E Series "0" Designs



E000A E001A E002A E003A E004A E006A E008A



E000S E001S E002S E003S E004S E006S E008S E009S



Model C108S
1X6 V-Groove T&G Face Applied Vertically (Standard)

C Series "1" Designs



C100A C101A C102A C103A C104A C106A C108A



C100S C101S C102S C103S C104S C106S C108S C109S

E Series "1" Designs

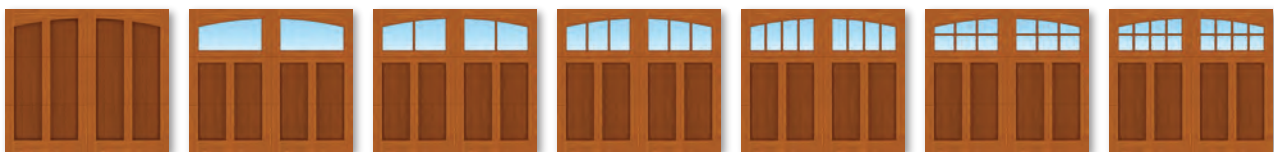

E100A E101A E102A E103A E104A E106A E108A



E100S E101S E102S E103S E104S E106S E108S E109S



Model E203S



C Series "2" Designs



C200A C201A C202A C203A C204A C206A C208A



C200S C201S C202S C203S C204S C206S C208S C209S

E Series "2" Designs



E200A E201A E202A E203A E204A E206A E208A



E200S E201S E202S E203S E204S E206S E208S E209S



Model E308A



C Series "3" Designs



C300A C301A C302A C303A C304A C306A C308A

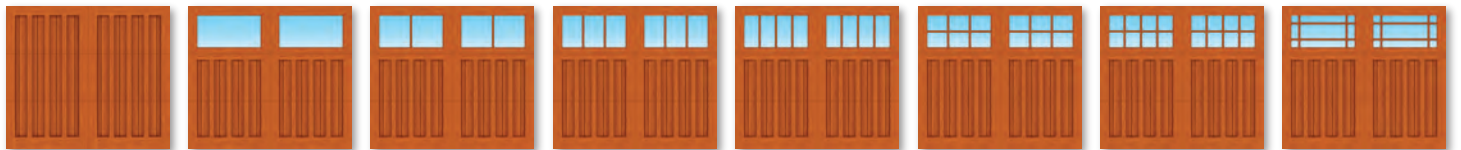

C300S C301S C302S C303S C304S C306S C308S C309S

E Series "3" Designs



E300A E301A E302A E303A E304A E306A E308A

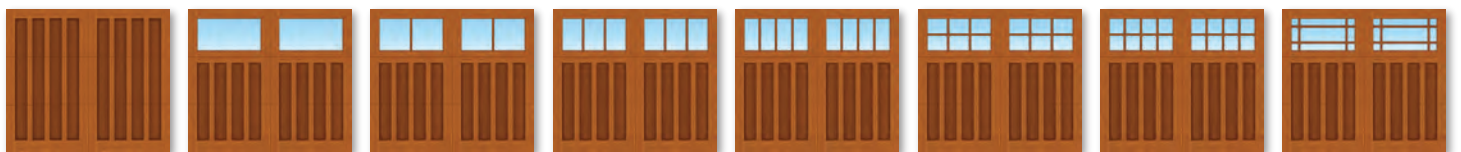

E300S E301S E302S E303S E304S E306S E308S E309S



Model CX04S
1x6 T&G Face Applied Vertically (Standard)



C Series "X" Designs



CX00A CX01A CX02A CX03A CX04A CX06A CX08A



CX00S CX01S CX02S CX03S CX04S CX06S CX08S CX09S

E Series "X" Designs



EX00A EX01A EX02A EX03A EX04A EX06A EX08A



EX00S EX01S EX02S EX03S EX04S EX06S EX08S EX09S



Model EA08A



C Series "A" Designs



CA00A CA01A CA02A CA03A CA04A CA06A CA08A



CA00S CA01S CA02S CA03S CA04S CA06S CA08S CA09S

E Series "A" Designs



EA00A EA01A EA02A EA03A EA04A EA06A EA08A



EA00S EA01S EA02S EA03S EA04S EA06S EA08S EA09S

C Series "V" Designs

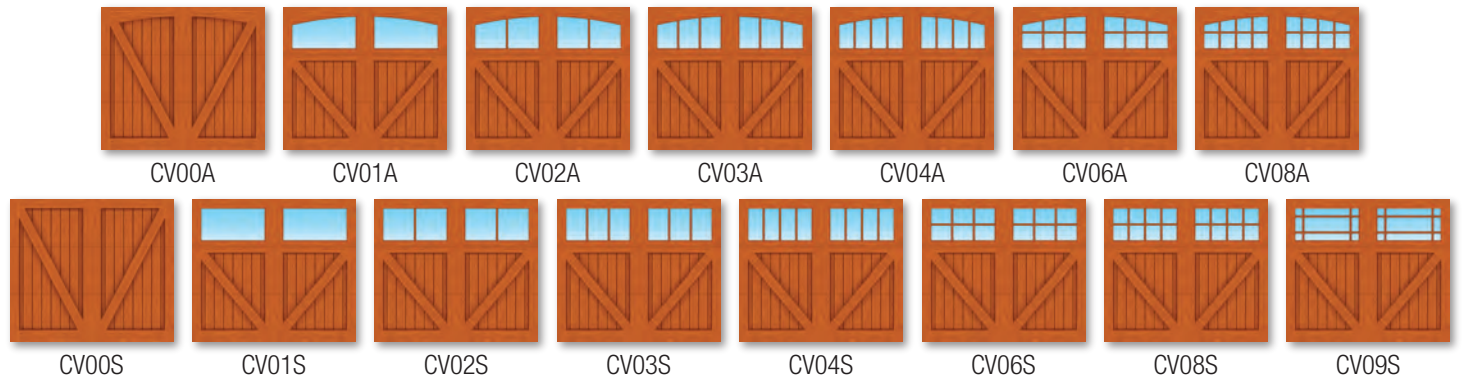

E Series "V" Designs

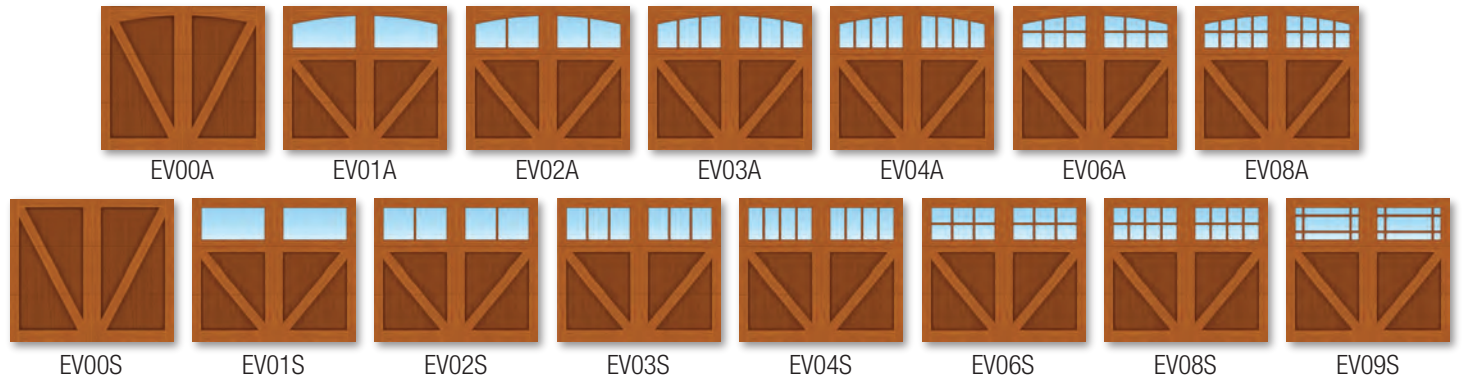

C Series "M" Designs

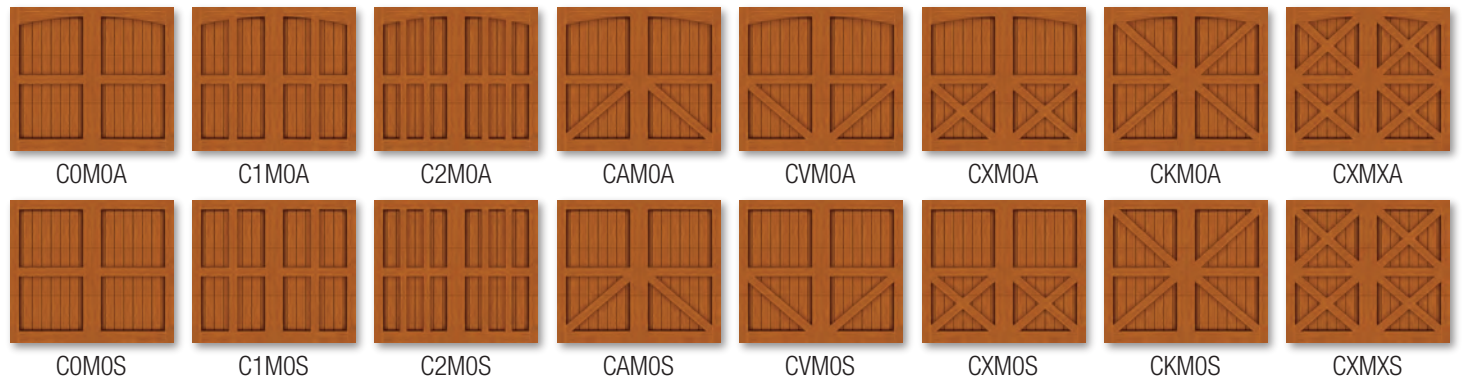

E Series "M" Designs

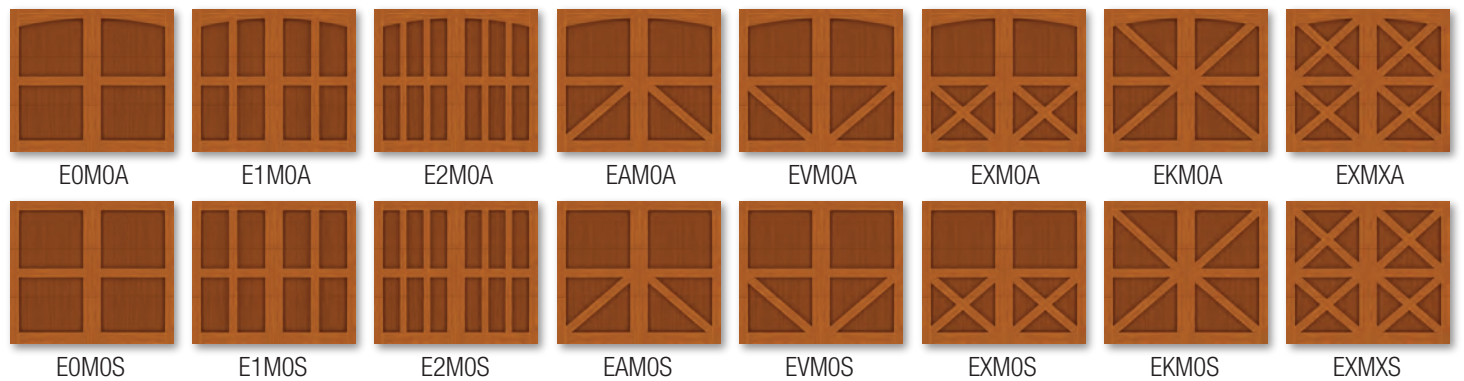



Model COLOA



C Series "L" Designs

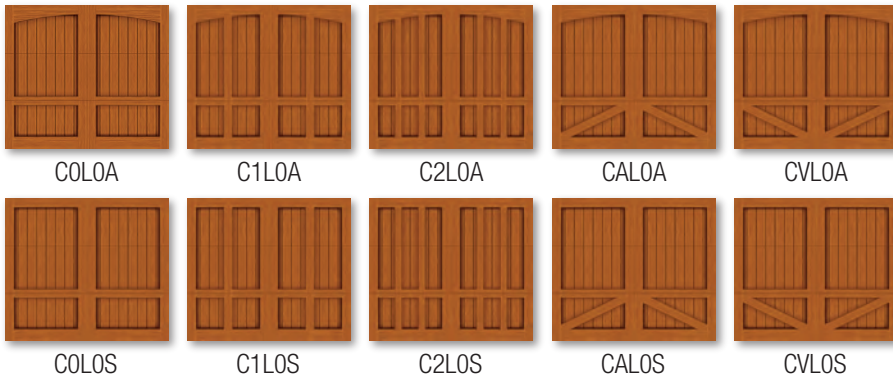

E Series "L" Designs

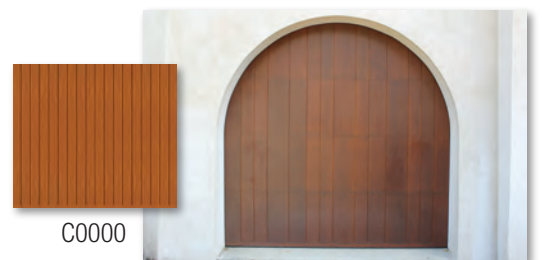
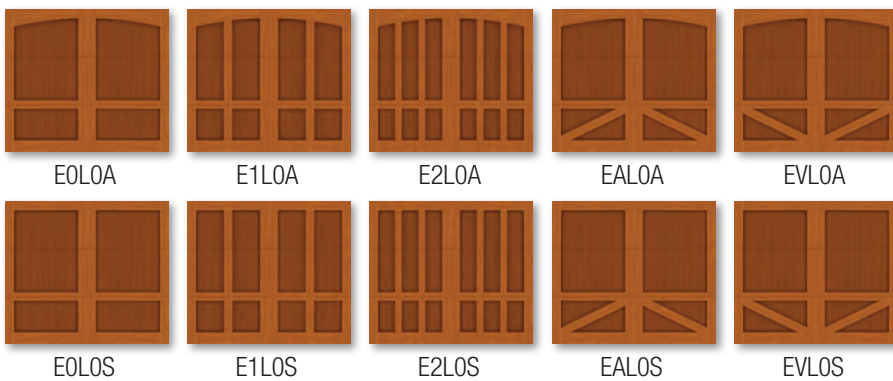

Optional Contemporary Designs

Northwest Door also offers wood contemporary design doors. The construction method and materials are the same as that of the Heritage Classic. Please provide your design idea to your Northwest Door Dealer or choose from one of the sample designs below.

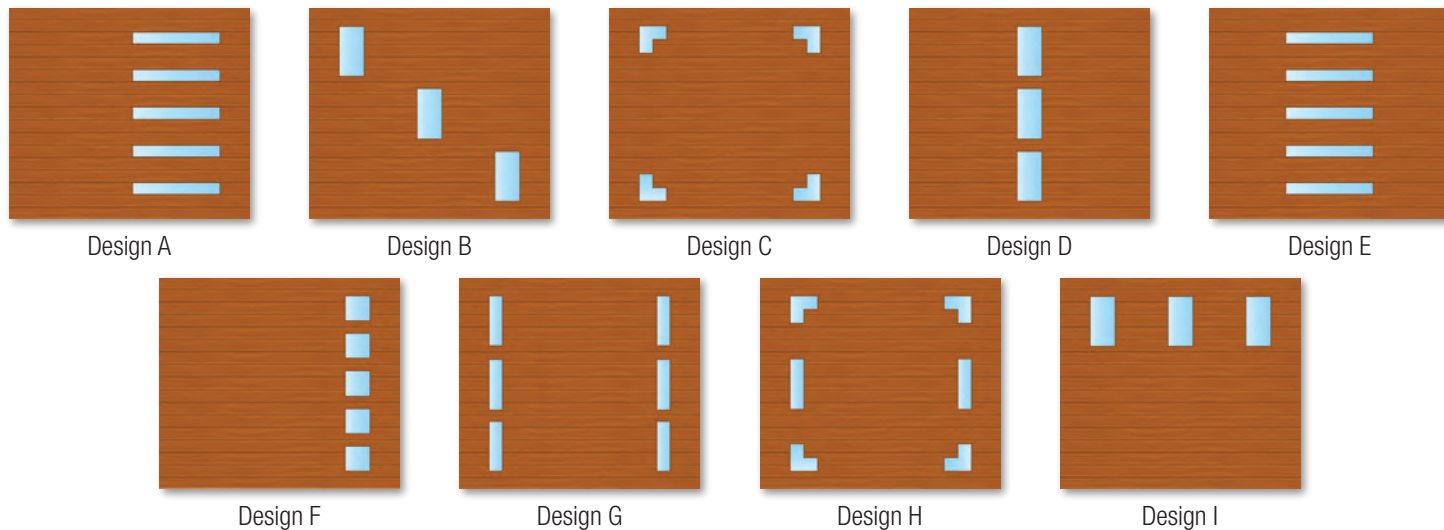

Glass Options

Windows are available on all door models. Window designs are shown by product on each product's page. 1/8" clear annealed glass is standard. Insulated, tempered, tinted and other specialty glass types are available to suit your particular needs. Additional glass options are available at www.NorthwestDoor.com.



Optional Decorative Hardware

Decorative hardware can be added to further enhance the appearance of your garage doors, using decorative handles and hinges or decorative handles only. Two Decorative Hardware Kits are available, handles only also available.



Malleable Iron
Black Powder Coat Finish



Stamped Steel, Crinkle Textured
Black Powder Coat Finish



Decorative Handles and Hinges

Decorative Handles Only

HÖRMANN NORTH AMERICA



Sparta, TN - North American Headquarters / Sectional Doors

FIVE PRODUCTION PLANTS, ONE FAMILY



Puyallup, WA - Sectional Doors



Montgomery, IL - Sectional Doors



Barrie, ON (CAN) - High Performance Doors



Burgettstown, PA - High Performance Doors

As one of the world's leading manufacturers of doors we're committed to providing the best quality, value, and selection.

Whether residential, commercial or industrial, we have the door you're looking for. Each Hörmann product gives you the perfect array of benefits and options to

Eastern and Central US
Toll Free: +1 877 654 6762
Email: info1@hormann.us
Website: hormann.us

Western US
Toll Free: +1 800 522 2264
Email: info@northwestdoor.com
Website: northwestdoor.com

Canada
Toll Free: +1 833 743 2443
Email: info@nwdca.ca
Website: nwdca.ca

AVAILABLE FROM:

